

Vacuum sensor (2 colors digital display)

MPS-34 series



- Easy checking with 2 colors display

Output switch ON / OFF display changes color according to the operation. 4 patterns settings.

- Wide pressure range, $-0.1 \sim 1.0\text{MPa}$

Vacuum pressure type: -101.3 kPa , Positive pressure: $-0.1 \sim 1\text{MPa}$
Compound pressure: $-101 \sim 500\text{kPa}$

- Easy settings

Use UP and DOWN keys to set the value.
Automatic settings mode available.

- Standard switch output and analog output

Switch output (open collector) Analog output (1 ~ 5V)

How to order

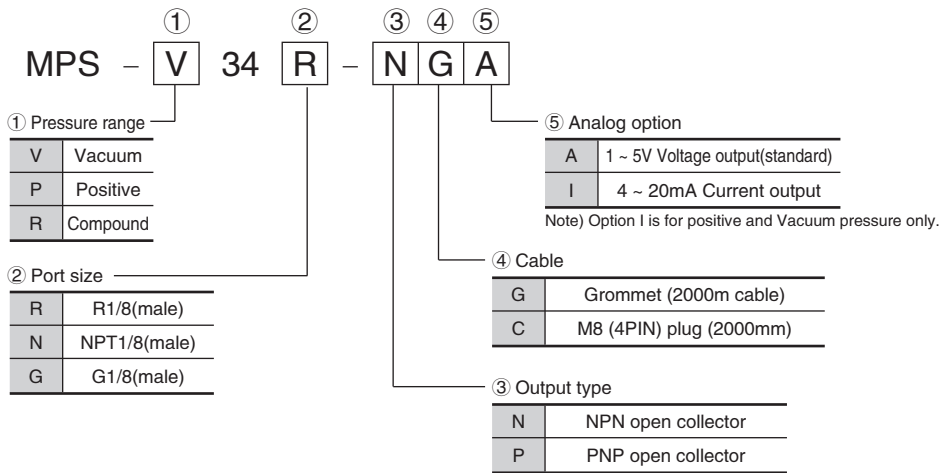

Mounting parts

Surface panel mounting of MPS-34

MPS-ACCH9

Adapter for panel mounting (2 types) with its protection cover.



L3 · F3 Bracket of MPS-34

MPS-ACCK10

L3 fitting, F3 fitting and 2 setting screws(M3) set.



M8 cable of MPS-34

MPS-ACCL8

Cable of 4 lead wires cable (2000mm length) with M8 connector.



Specifications

Description		Unit	MPS-V34	MPS-P34	MPS-R34
Fluid			Air (non corrosive, nonflammable gas)		
Diaphragm			Silicon diaphragm		
Pressure range		kPa	-101.3 ~ 0kPa	-0.1 ~ 1MPa	-101 ~ 500kPa
Proof pressure		MPa	0.3	1.5	0.8
Operating ambient temperature		°C	0 ~ 50		
Operating humidity		%	35 ~ 85 RH (without condensation)		
Port size			R1/8 (male), NPT1/8 (male), G1/8 (male) Inlet port size M5(female)		
Power supply		V	DC12 ~ 24 ± 10% , Ripple (Vp-p) less than 10%		
Power consumption		mA	less than 45		
Switch output	type		NPN or PNP open collector 1 output		
	Current load	mA	max.125mA		
Analog output (Option)	Voltage output	V	DC1 ~ 5 (± 2.5%), linearity less than ± 1% of F.S., output impedance 1kΩ 4 ~ 20 ± 2.5%, linearity less than ± 1% of F.S		
	Current output	mA	Maximum load impedance 300 Ω (at 12V power), 600 Ω (at 24V power) Minimum load impedance 50 Ω		
Repeatability		%	± 0.2 F.S., 1digit or less		
Temperature characteristic			Less than ± 2% of F.S.(At standard temperature 25°C , range 0 ~ 50°C)		
Response time		ms	Less than 2.5(Variable 24, 250, 500, 1000, 1500 options)		
Hysteresis			Variable		
Display	Digital display		3 1/2 digits 7 segments, 2 colors (Red/Green) LCD		
	Operation		LCD (Green when ON)		
Resolution			0.1kPa	0.01MPa	1kPa
Protection structure			IP40		
Vibration resistance			10 ~ 55Hz, total amplitude 1.5mm (2 hours in direction of XYZ)		
Shock resistance		m/s ²	100 (3 times in direction of XYZ)		
Voltage resistance			AC1000V 1 minute (Between lead and case)		
Electrical connection			Grommet or M8 connector		
Cable	Grommet		φ 4 0.15mm ² 4 lead wires 2m		
	M8 connector		φ 4 0.15mm ² 4 lead wires 100mm (M8 4PIN with male connecto)		
Fittings			L3, F3 fittings		
Mass	Grommet	g	75 (45with lead wire)		
	M8 connector		45 (with connector and lead wire)		

Note 1) Analog output of positive pressure type (P) in range of pressure 0 to 1 Mpa can output DC1-5V and 4-20mA. In range of pressure -0.1 to 0 MPa it does not output.
Note 2) Current output type is available for Vacuum type (V) and Positive pressure type (P) only.

Internal circuit

NPN output (Analog voltage output)

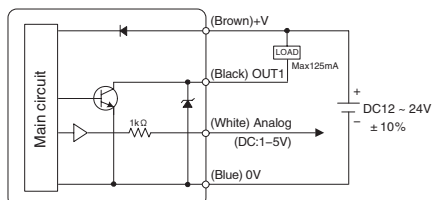

PNP output (Analog voltage output)

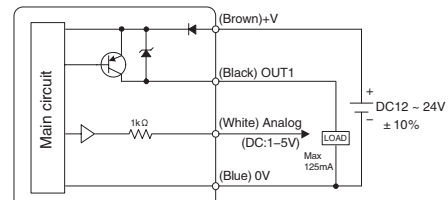

NPN output (Analog current output)

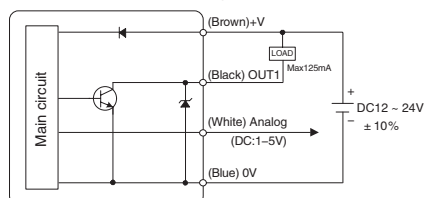

PNP output (Analog current output)

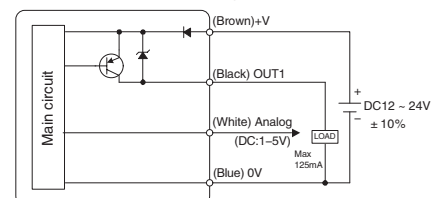

Display description

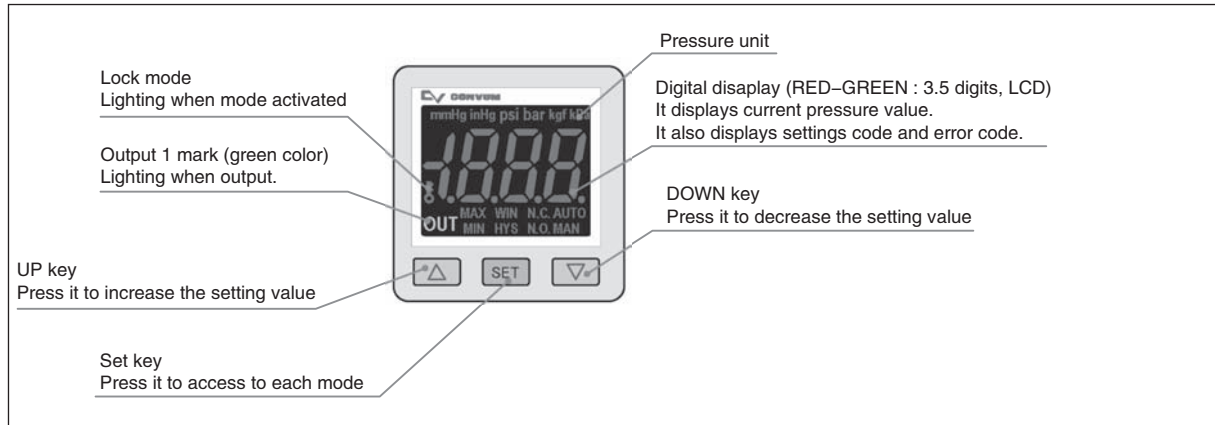

Setting method

Please refer to the instruction manuals for details

Initial settings mode

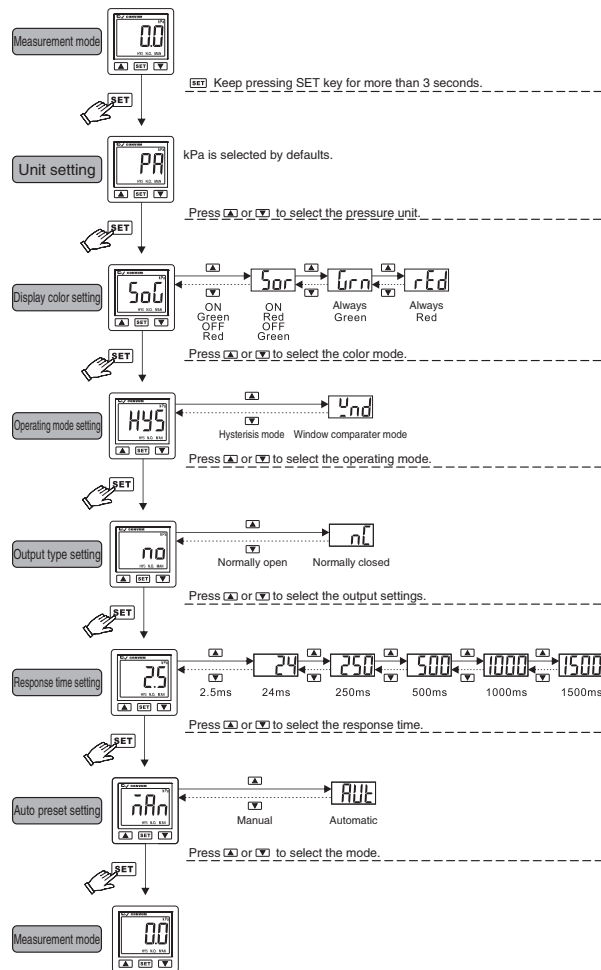

Manual settings

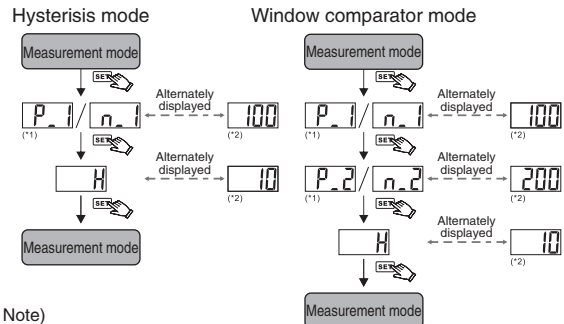

Note)

- When normally open mode is selected, it displays [P_], when normally closed mode is selected, it displays [n_].
- Pressure value change:
When pressing one time to Δ , one digit increases.
When keeping pressing to Δ , setting value keep increasing.
When pressing one time to ∇ , one digit decreases.
When keeping pressing to ∇ , setting value keep decreasing.
- After finishing the settings of the output type, press SET to switch with pressure value setting mode.
If 10 seconds pass within pressing any key, it switches automatically with pressure value setting mode.

Auto setting mode

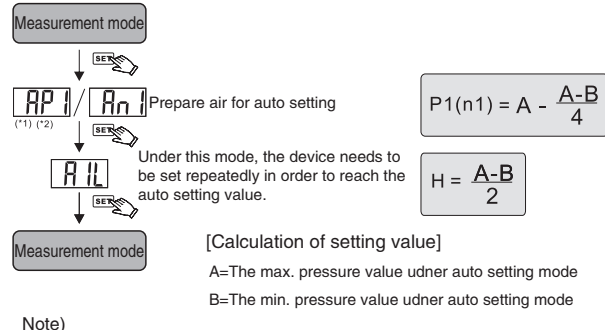

Note)

- When normally open mode is selected, it displays [AP1], when normally closed mode is selected, it displays [An1].
- If auto pressure value setting is not needed, press Δ and ∇ at the same time to switch with measurement mode.

Other settings

① Zero reset setting:

Press Δ and ∇ at the same time until the "00" is displayed.
Release the keys to end the settings.

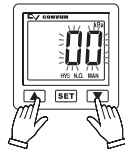

② The MAX. value display mode

Keep pressing Δ for 2 seconds to enter the MAX. value mode.
Pressure sensor will detect the MAX. value and keep display.
Press Δ for 2 seconds to return to measurement mode.

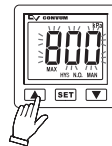

③ The MIN. value display mode

Keep pressing DOWN ∇ 2 seconds to enter the MIN. value mode.
Pressure sensor will detect the MIN. value and keep display.
Press ∇ for 2 seconds to return to measurement mode.

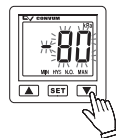

④ Fine adjustment mode

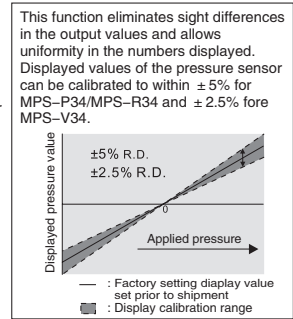
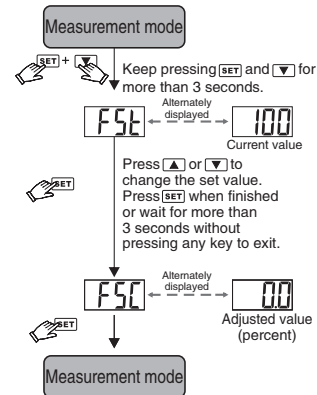

Note
MPS-P34: When display unit is in Mpa, setting resolution is 0.001MPa.
MPS-R34: When display unit is in kpa, setting resolution is 1kPa.
MPS-V34: When display unit is in kpa, setting resolution is 0.1kPa.

Dimensions

Unit : mm <inch>

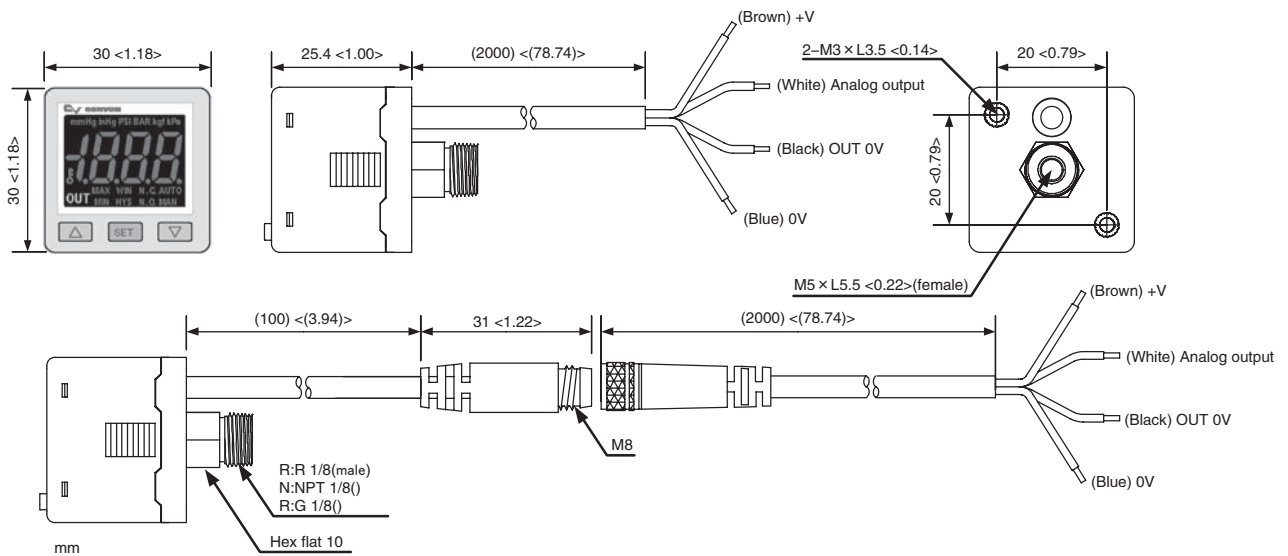

L3 bracket fitting

F3 bracket fitting

Surface mounting panel

