

에코 패드 PK 시리즈

패드		자바라형 패드	PKBG
		평형 패드	PKMG

특징

- 고무와 금속의 분리 처리가 가능
패드(고무)와 연결나사(금속) 2가지 부품으로 구성.
- 패드 내면에 미끄럼 방지용 홈설치
수분이나 유분기가 있는 워크의 경우, 그립력이 증가하고, 옆으로의 미끄러짐을 방지.
- 2 경도 고무 패드
고정부는 경도를 높여주고, 흡착부는 부드럽게 하여 확실한 흡착을 실현.

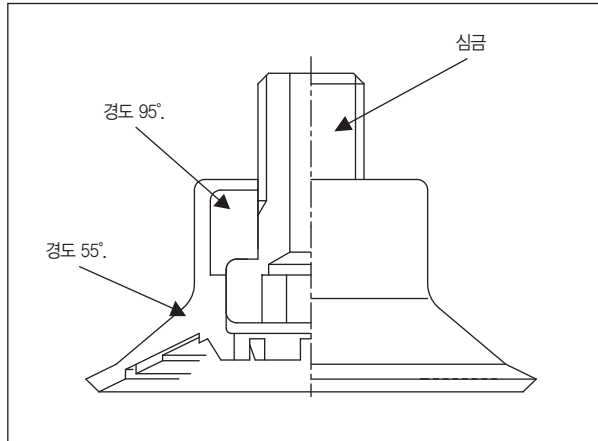

PKBG / PKMG

형식번호

PK ^① M G - ^② 60 - ^③ W

① 패드 형상	
B	자바라형 패드
M	평형 패드

② 패드 사이즈 mm	
30	Ø 30 (평형만)
30T	Ø 30 (평형만)
40	Ø 40 (평형만)
40T	Ø 40 (평형만)
50	Ø 50 (자바라형만)
50M	Ø 50 (평형만)
50T	Ø 50 (평형만)
60	Ø 60
60T	Ø 60 (평형만)
75	Ø 75 (평형만)
75T	Ø 75 (평형만)
80	Ø 80 (자바라형만)
80H	Ø 80 (3단 자바라형)
85K	Ø 85 (평형만)
100	Ø 100 (평형만)
100K	Ø 100 (평형만)
100T	Ø 100 (평형만)
110	Ø 110 (자바라형만)

③ 패드 고무 재질	
W	니트릴 2경도 55°/95°

패드 표준사양

기호	재질	경도(Hs)	사용 온도 범위	색
W	니트릴 2경도	A55 · 95/S	-26 ~ 120℃	흑색

금구 대응일람

형식 번호	자바라형 패드					평형 패드														
	50	60	80	80H	110	30	30T	40	40T	50M	50T	60	60T	75	75T	85K	100	100K	100T	
TN-PKM-30-M10						○	○	○	○		○									
TN-PK-100-M10	○	○	○	○	○					○		○	○	○	○	○	○	○	○	○
TN-PK-100-M10F	○	○	○	○	○					○		○	○	○	○	○	○	○	○	○
TN-PK-100-M12	○	○	○	○	○					○		○	○	○	○		○			○
TN-PK-6710	○	○	○	○	○					○		○	○	○	○		○			○

외형치수도

단위 : mm

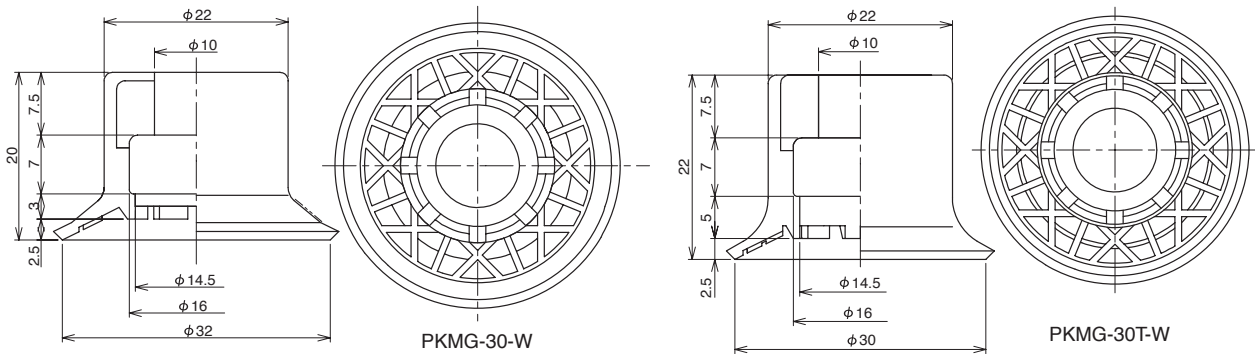

진패드

외형치수도

단위 : mm

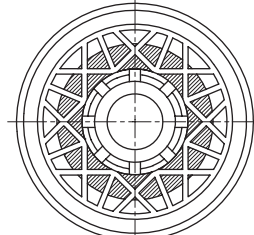
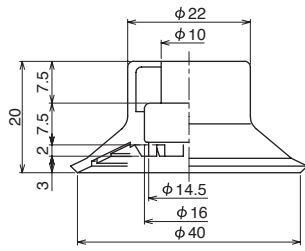

PKMG-40-W

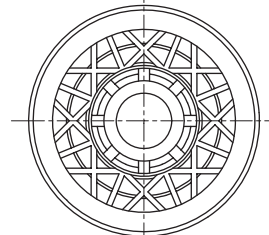
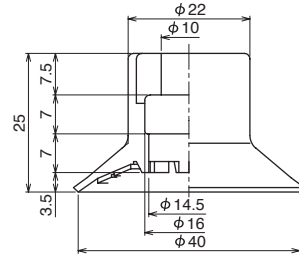

PKMG-40T-W

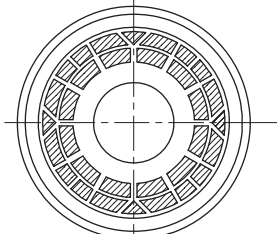
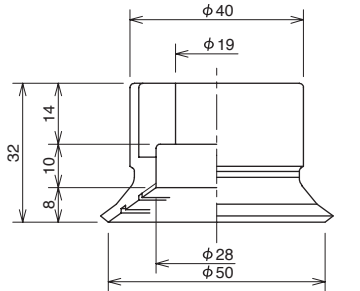

PKMG-50M-W

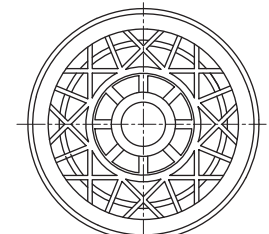
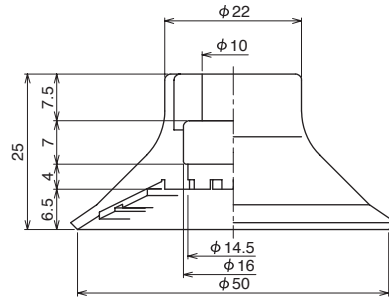

PKMG-50T-W

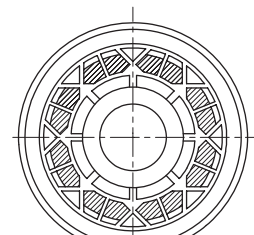
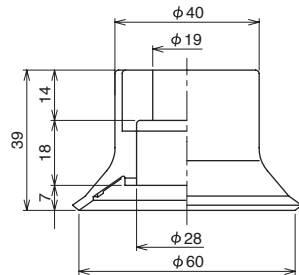

PKMG-60-W

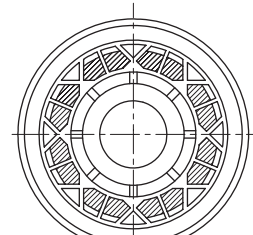
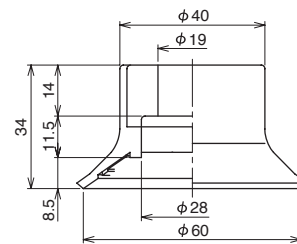

PKMG-60T-W

제품명

외형치수도

단위 : mm

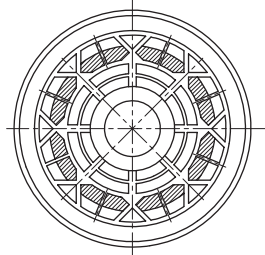
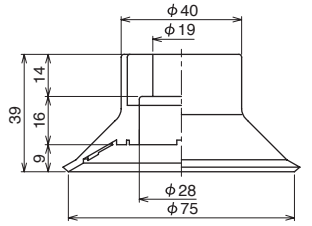

PKMG-75-W

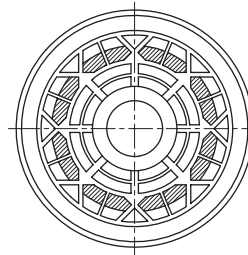
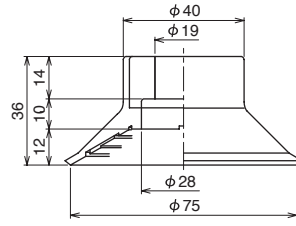

PKMG-75T-W

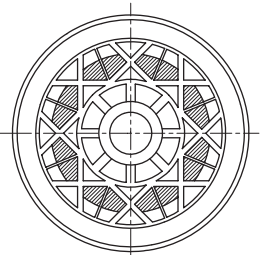
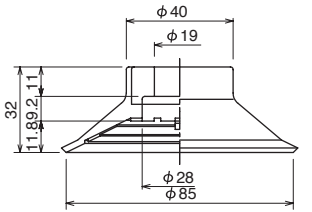

PKMG-85K-W

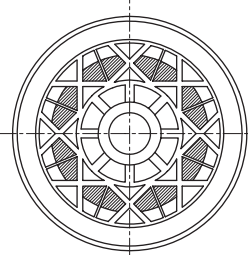
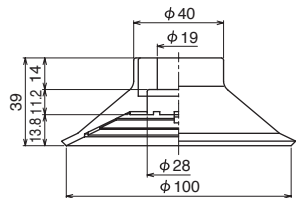

PKMG-100-W

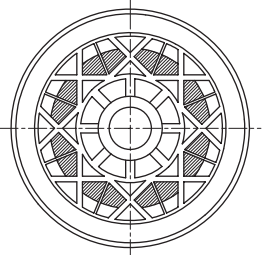
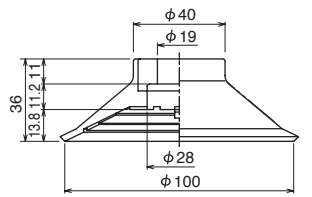

PKMG-100K-W

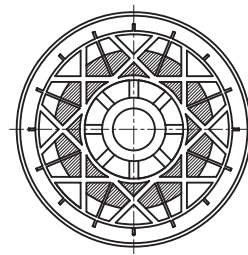
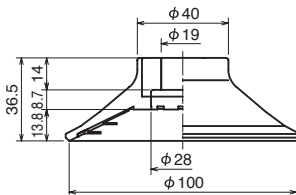

PKMG-100T-W

진짜PK

외형치수도

단위 : mm

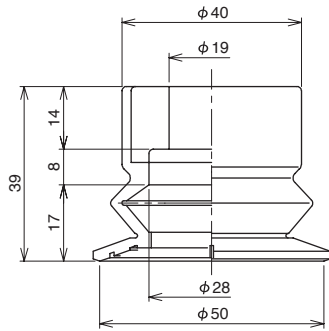

PKBG-50-W

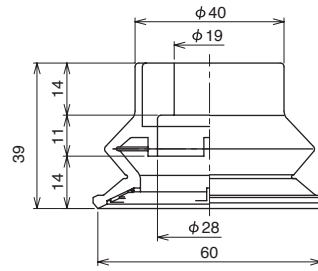

PKBG-60-W

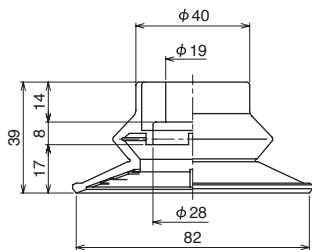

PKBG-80-W

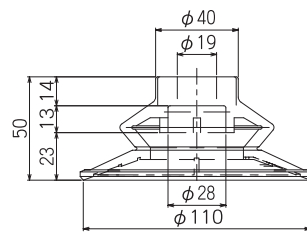

PKBG-110-W

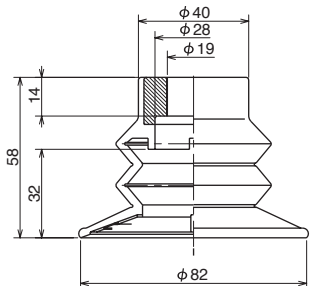

PKBG-80H-W

